

# PRIME

ARCHERY



PRODUCT MANUAL

# BOW FEATURES

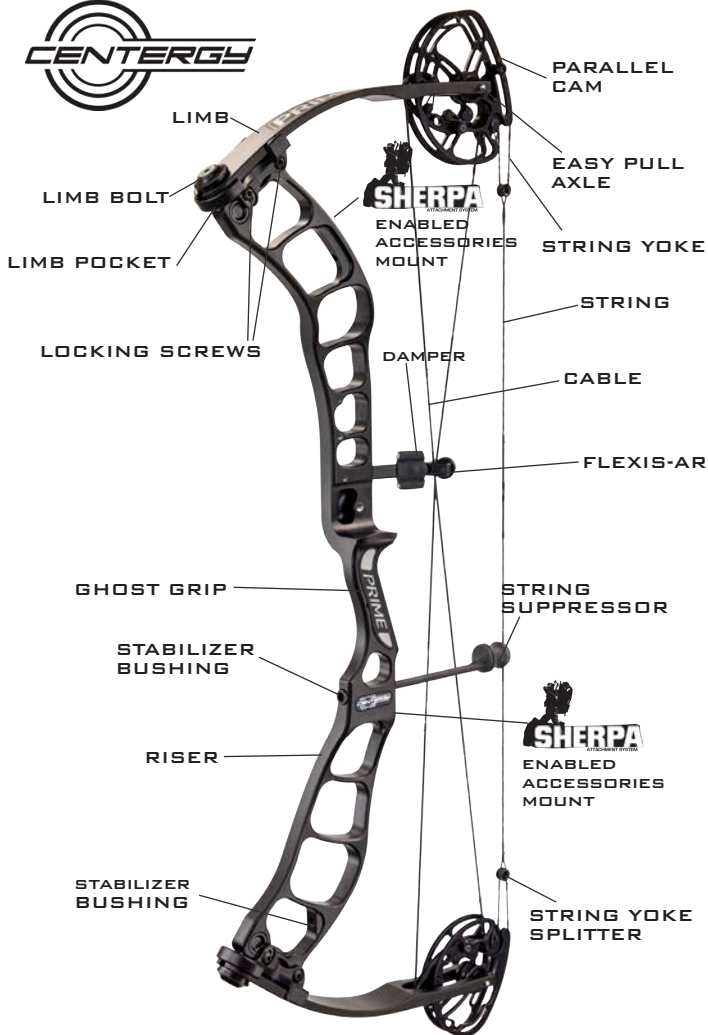

A  
C  
C  
E  
S  
S  
O  
R  
I  
E  
S  
S  
C  
U  
L  
E  
S  
A  
C  
C  
E  
S  
S  
O  
R  
I  
E  
S

# CONGRATULATIONS ON YOUR NEW PRIME

G5 Outdoors would like to welcome you as part of the Prime team. Prime bows are engineered, machined, and assembled with the highest quality craftsmanship in the USA. As part of the Prime team, you will experience the most advanced technology and quality in today's archery industry with your new bow purchase. You will experience comfort, forgiveness, and accuracy that is unlike any other bow. Please review the entire manual before operating your new Prime bow. Many adjustments require the use of a bow press: **please consult your local Prime dealer on general setup and tuning. Please also reference the Prime Shield Program on the back cover of this manual for full warranty information.**



ATA: 33.25"  
Draw Length: 24.5"-31"  
(for 30.5" and 31" add 1"  
brace height)  
Brace Height: 6.5"  
Mass Weight: 4.3 lbs.  
Draw weight: 40, 50, 60,  
65, 70, 80 lbs.  
IBO Speed: 333 fps.



ATA: 33.25"  
Draw Length: 24.5"-31"  
(for 30.5" and 31" add 1"  
brace height)  
Brace Height: 6.5"  
Mass Weight: 4.05 lbs.  
Draw weight: 40, 50,  
60lbs.  
IBO Speed: 333 fps.



ATA: 35.25"  
Draw Length: 24.5"-31"  
(for 30.5" and 31" add 1"  
brace height)  
Brace Height: 6"  
Mass Weight: 4.5 lbs.  
Draw weight: 40, 50, 60,  
65, 70, 80 lbs.  
IBO Speed: 338 fps.

String Length: 26.7"  
Cable Length [2x]: 40.5"  
Upper Yoke: 34.8"  
Lower Yoke: 30.6"

String Length: 26.7"  
Cable Length [2x]: 40.5"  
Upper Yoke: 34.8"  
Lower Yoke: 30.6"

String Length: 28.7"  
Cable Length [2x]: 42.5"  
Upper Yoke: 34.8"  
Lower Yoke: 30.6"



ATA: 36"/39"  
Draw Length: 23.5"-30"/24.5"-31"  
Brace Height: 6.75"  
Mass Weight: 4.3 lbs / 4.6 lbs..  
Draw weight: 40, 50, 60, 70 Lbs  
IBO Speed: 325fps / 323fps  
Cable Length [2x]: 45.75"  
Yoke Length[2x]: 32.3" [Cam A]  
30.1" [Cam B] 26.82" [Cam C]



Axle to Axle: 33"  
Brace Height: 6.75"  
IBO Speed: 335 FPS  
Draw Length: 26" - 30"  
String Length: 26"  
Cable Length [2x]: 39.41"  
Yoke Length [2x]: 33.75"

G5PRIME.COM



# SAFETY

## **NEVER “DRY FIRE” YOUR BOW**

This means to draw and release the string without an arrow. Firing a bow without an arrow to absorb the energy can cause severe damage to the bow, the shooter, and nearby persons. Let the string down slowly.

## **CAREFULLY INSPECT YOUR BOW BEFORE EVERY USE**

Inspect your bow before every shooting session, inspecting the limbs, strings, cable(s), limb bolts, etc. If you notice any frayed or cut strings or cable(s) and/or cracks or splintering limbs, immediately cease use of the bow and contact your local pro shop.

## **ALWAYS BE SURE OF YOUR TARGET**

Make sure there are no persons, buildings, vehicles, or livestock behind your target. Make sure to have a proper backstop to properly stop arrows.

## **ALWAYS INSPECT YOUR ARROW**

This means to inspect all your arrows, nocks, and fletching (per manufacturer recommendation) for cracks, bends, or anything that will compromise its safety. Use of cracked or damaged arrows will result in personal injury.

## **KEEP BOW FROM BEING EXPOSED TO EXCESSIVE HEAT OR DAMPNESS**

Exposing the bow to excessive heat, such as keeping the bow in a closed vehicle during sunny days, can cause limb/string and cable(s) failure. Never store a wet bow for prolonged periods.

## **ALWAYS BE SAFE**

Make sure to know all warnings and abide by them. Never aim or shoot at a person. Never shoot straight up. Wear safety glasses while working on the bow. Be careful handling broadheads or anything sharp around the string and cable(s). Cutting or nicking these can cause serious injury to you and others. Children MUST be supervised by a responsible adult.

## **WARNING!!!!**

**YOU'RE RESPONSIBLE FOR ARCHERY SAFETY**

# SETUP

## VISIT YOUR LOCAL PRIME DEALER FOR BOW SETUP WHICH INCLUDES:

- Adjusting draw length and draw weight
- Replacing and/or servicing string and/or cables
- Checking and adjusting cam timing
- Proper arrow selection
- Proper selection and use of accessories

## DRAW WEIGHT:

All PRIME™ bows have 10 pound draw weight adjustment capability. For instance, if you have a 60 pound bow, that bow is capable of a 50-60 pound adjustment. To adjust the draw weight, loosen the Limb Pocket Locking Screws first, using an Allen wrench. Both screws must be loosened before adjusting the draw weight. Then, use a 3/16" Allen wrench to adjust the Limb Bolts equally by turning the Limb Bolt counterclockwise to decrease weight and clockwise to increase weight. Each full rotation of the limb bolt will alter the draw weight 2-3 pounds. Never back out the limb bolt more than five full rotations from maximum draw weight. To adjust the draw weight, use an allen wrench to loosen the limb pocket locking screws first. (See picture)

## BROADHEADS:

Most archers discover that they must make slight tuning adjustments when switching from field points to broadheads, both fixed and expandable, and even when using same weights. Broadheads can have different aerodynamics than field points and require slight adjustments in nocking point, centershot, and/or your sight. Always test your broadhead flight before going hunting to make sure of your arrow flight, no matter what kind of broadhead design.



G5PRIME.COM



# SETUP CONT.

## CENTER SHOT:

To set the approximate center shot of the bow, align the arrow with your rest so that it falls through the center of the grip.

13/16" from the inside of the riser can be used as a starting point, but may require some fine tuning.

For Prime models with the Ultra Fit Grip, there are two white indicating arrows on the back of the grip that can be used for center shot reference. For proper center shot alignment, align the string through the center of both white indicating arrows on the back of grip. Then, align the bow string down the center of the arrow.

## NOCKING POINT:

There are many variables involved in determining where to install your nock point. These include: type of arrow, arrow rest, fingers or release shooting, and your hand placement on the bow. As a general rule of thumb, the nock point will be set perpendicular, or  $90^{\circ}$ , to the back of the riser. The arrow centerline should be centered with the berger hole. [See Fig.1] Again, this is only a starting point; you might need to fine-tune this during your setup.

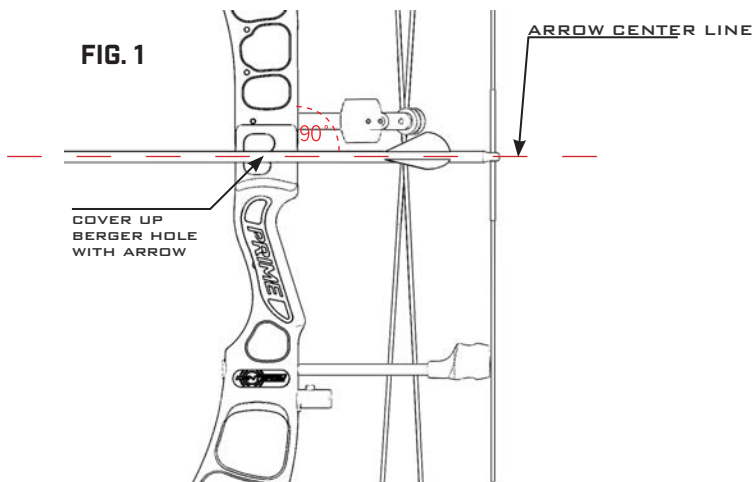

# SETUP CONT.

## GHOST GRIP:

The newly designed Ghost Grip gives hunters and shooters maximum comfort and adjustability. Depending on shooting style or preference, shooters may prefer a wider or thinner grip. If a shooter wishes to have a wider grip style, the Ultra Fit Grip can be added by taking out the Ghost Grip side plates (attached by snap-on tabs) and using the Allen screws provided to bolt on the Ultra Fit Grip. (Rival and Ion models only).

## DRAW LENGTH:

Parallel™ Cams are draw length specific cams in intervals of 1/2". To change out draw lengths, please seek the professional help of an authorized PRIME dealer or pro-shop. Please note: To ensure proper use, make sure cam washers are within .005" of thickness from one side to the other. This will place the cam within the center of the limb which is important to reduce cam lean. (See Fig 2.)

## LET-OFF:

The PCXL/TRK cams have an adjustable let-off of up to 85%.

DL	CENTERGY	CENTERGY AIR	CENTERGY HYBRID
31*	TRK1	TRK1	TRK1
30.5*	TRK2	TRK2	TRK2
30	TRK1	TRK1	TRK1
29.5	TRK2	TRK2	TRK2
29	TRK3	TRK3	TRK3
28.5	TRK4	TRK4	TRK4
28	TRK5	TRK5	TRK5
27.5	TRK6	TRK6	TRK6
27	TRK7	TRK7 </td <td>TRK7</td>	TRK7
26.5	TRK8	TRK8	TRK8
26	TRK9	TRK9	TRK9
25.5	TRK10	TRK10	TRK10
25	TRK11	TRK11	TRK11
24.5	TRK12	TRK12	TRK12

\*LD model adds 1" to all TRK cams.

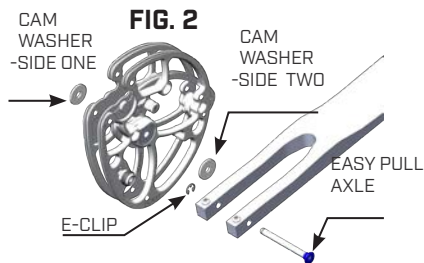

**WARNING!!!! DO NOT DRAW PARALLEL CAM EQUIPPED BOWS WITHOUT BOTH DRAW STOPS PROPERLY INSTALLED!**

G5PRIME.COM



# PCS CAMS

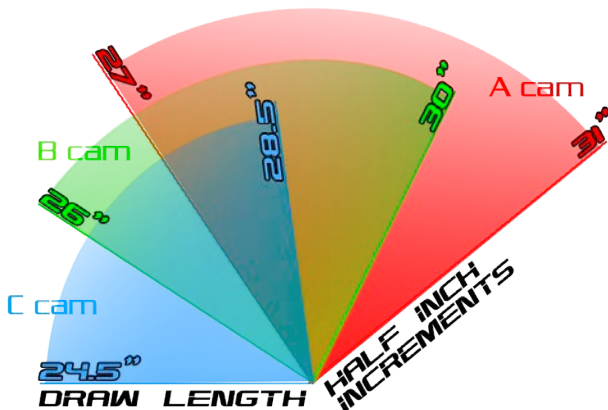

**\*ONE 39 DRAW LENGTH SHOWN. (SUBTRACT 1" FOR ONE 36 SERIES BOWS)\***

A-Cam represents the least aggressive.

B-Cam represents the best of both worlds, Smoothness + Speed.

C-Cam gives more performance, increased speed for shorter draw lengths.

Each cam requires a specific yoke and rocker set. Cam sets will include required rocker and yoke set. Cables, center string and limbs stay the same.

New PCS cams give you the option of limb stops or cable stops depending on shooting style.





DRAW LENGTH	A CAM	B CAM	C CAM
31	PCS1		
30.5	PCS2		
30	PCS3	PCS1	
29.5	PCS4	PCS2	
29	PCS5	PCS3	
28.5	PCS6	PCS4	PCS1
28	PCS7	PCS5	PCS2
27.5	PCS8	PCS6	PCS3
27	PCS9	PCS7	PCS4
26.5		PCS8	PCS5
26		PCS9	PCS6
25.5			PCS7
25			PCS8
24.5			PCS9

**STX**  
**39 1/2**

\*NOTE: Shaded area represents cam/mod combination in-line bows will be shipped.

DRAW LENGTH	A CAM	B CAM	C CAM
30	PCS1		
29.5	PCS2		
29	PCS3	PCS1	
28.5	PCS4	PCS2	
28	PCS5	PCS3	
27.5	PCS6	PCS4	PCS1
27	PCS7	PCS5	PCS2
26.5	PCS8	PCS6	PCS3
26	PCS9	PCS7	PCS4
25.5		PCS8	PCS5
25		PCS9	PCS6
24.5			PCS7
24			PCS8
23.5			PCS9

**STX**  
**36 1/2**

\*NOTE: Shaded area represents cam/mod combination in-line bows will be shipped.

# SETUP CONT.

FIGURE 3

**TRK**  
PARALLEL CAM TECHNOLOGY

**CABLE STOP**  
(not available on pcxl cams)

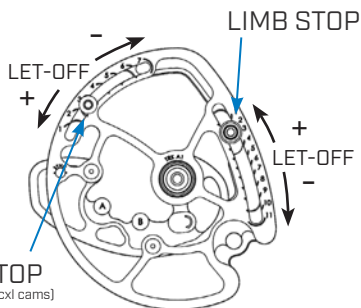

## PCS/TRK CAM LIMB STOP OR CABLE STOP ADJUSTMENT:

The newly designed PCS cam that is featured on the One series target bows was developed to allow for a firm back wall or a softer back wall depending on the archer's preference. This is accomplished by either shooting off from the limb stops or cable stops. For optimum performance, the PCS cam should be used with only the limb stops or cable stops, not both. If a firm back wall is desired, leave the limb stops in place and remove the cable stops from the cam. Once the cable stop is removed, the limb stops can be adjusted to reach your desired let-off. If a softer back wall is desired, remove the limb stops. The cable stops are adjustable, creating an adjustable let-off of up to 85%. [See Figure 3]

## LET-OFF:

Draw stops can be adjusted to micro-adjust draw length from each cam's specified draw length, and adjust let-off from 85% on down to 65% [PCXL/TRK cams will max out at 85% let-off]. Pushing the limb stops inward will result in decreased let-off and shorter draw length, while moving the limb stops outward increases let-off and draw length. To adjust them, use a 9/64" Allen wrench, loosen 8-32" cap screw one full turn, and slide both the upper and lower limb stops equal amounts. Finally, retighten the 8-32" cam screws on both limb stops.

**WARNING!** DO NOT DRAW PARALLEL CAM EQUIPPED BOWS WITHOUT BOTH DRAW STOPS PROPERLY INSTALLED!!!

# BOW PRESS

ALWAYS USE A DOUBLE PULL STYLE PRESS, LIKE IN FIG. 1 AND FIG. 2, WHEN WORKING ON YOUR BOW.

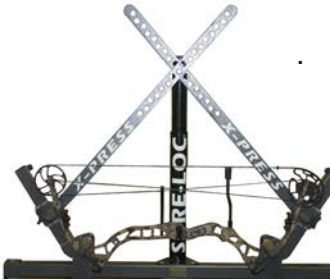

**FIG. 1** PRESSES BOW  
IN TWO PLACES

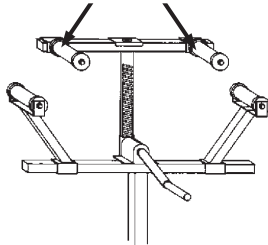

**FIG. 2** PRESSES BOW  
IN TWO PLACES

NEVER USE A SINGLE PULL STYLE PRESS, LIKE IN FIG. 3, WHERE PRESSURE IS PLACED ON THE GRIP ONLY.

▶ **WARNING!** NEVER USE  
A SINGLE PULL PRESS!

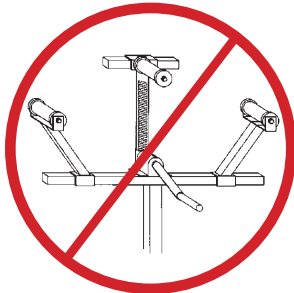

**FIG. 3** PRESSES BOW  
IN ONE PLACE

# MAINTAINING YOUR BOW

## **PERIODICALLY CHECK YOUR STRING & CABLES:**

Always check your bow for frayed string, yokes and cables. Replace damaged string, yokes and/or cables immediately. Keep your PRIME strings waxed and maintained. If you replace the string, yokes, and/or cables make sure to only use PRIME replacements and proper lengths for best performance and reliability.

## **ECCENTRIC BEARINGS:**

All PRIME bows have self lubricating/sealed bearing systems and do not need to be lubricated.

## **FLEXIS-AR TECHNOLOGY:**

PRIME bows are equipped with Flexis-AR cable guard technology that should never wear out with normal use. Periodically, check the condition of the cables above and below the Flexis-AR to see if any premature wearing/fraying has occurred. Replace Flexis-AR immediately if damaged.

## **STRING YOKE SPLITTER:**

All PRIME bows are equipped with String Yoke Splitters in the bowstring. Make sure these are installed as shown to the right.

## **STORAGE:**

Do not store your PRIME bow in areas that are subject to excessive heat such as the trunk of an automobile, attic or garage. Excessive heat can severely damage the limbs, strings, cables, and other bow parts and is not covered under the manufacturer's warranty. After use in damp or wet environments, dry off the bow completely before storing.



**WARNING!** DO NOT DRAW/FIRE A PRIME BOW WITHOUT SPLITTER PROPERLY INSTALLED!

# BOW OWNER'S RECORD

FILL IN THE FOLLOWING PERSONAL BOW RECORD FOR YOUR REFERENCE.

BOW SERIAL NUMBER:

BOW MODEL:

PURCHASED FROM:

PURCHASE DATE:

DRAW LENGTH:

DRAW WEIGHT:

STRING LENGTH:

CABLE(S) LENGTH:

YOKE(S) LENGTH:

## IMPORTANT:

SAVE YOUR SALES RECEIPT AND SERIAL NUMBER OF YOUR NEW BOW. THE SALES RECEIPT AND SERIAL NUMBER ARE YOUR PROOF OF DATE OF PURCHASE. THIS PROOF OF DATE OF PURCHASE WILL BE REQUIRED SHOULD YOUR BOW EVER NEED WARRANTY SERVICE.

PLEASE ATTACH YOUR SALES RECEIPT HERE FOR SAFEKEEPING.

NOTES:

G5PRIME.COM



# PRIME™ SHIELD PROGRAM

## **LIMITED LIFETIME WARRANTY**

YOUR PRIME BOW IS COVERED FROM ANY MANUFACTURER DEFECTS FOR THE LIFE OF THE BOW TO THE ORIGINAL OWNER. DOES NOT INCLUDE STRINGS, CABLES OR RUBBER ACCESSORIES DUE TO NORMAL WEAR.

**NOTICE:** PRIME BOWS MUST BE REGISTERED BY AUTHORIZED PRIME DEALERS. REGISTRATION AND SHIELD BENEFITS LIMITED TO ORIGINAL OWNER. BOWS PURCHASED IN USED CONDITION UNDER ANY CIRCUMSTANCES ARE NOT ELIGIBLE FOR REGISTRATION.

## **LIFETIME REPLACEMENT OF STRINGS/CABLES**

AN INDUSTRY FIRST, PRIME OWNERS ARE ELIGIBLE FOR A FREE SET OF STRING/CABLES EVERY TWO YEARS (FROM DATE OF REGISTRATION) FOR THE LIFE OF THE BOW TO THE ORIGINAL OWNER.

## **100 CYCLE ASSURANCE**

FIRST OF ITS KIND - WE CYCLE EVERY PRIME BOW 100 TIMES SO STRINGS ARE STRETCHED AND SETTLED SO THERE IS NO RETUNING AFTER YOU PURCHASE YOUR BOW.

## **SIX MONTH TUNE UP (UNITED STATES ONLY)**

TO ENSURE YOU'RE READY FOR THE FIELD, RECEIVE A FREE TUNE UP AT YOUR LOCAL PRIME DEALER WITHIN SIX MONTHS OF THE PURCHASE OF YOUR BOW. YOUR BOW MUST BE REGISTERED TO QUALIFY.



**THIS WARRANTY IS VOID IF:**

The PRIME bow is purchased from an unauthorized PRIME dealer  
The PRIME bow is purchased via the Internet  
There is damage caused by abuse, mishandling, dry-firing, alteration or modification to the original product.  
All cables, strings, bearings and rubber parts on the PRIME bow are not covered under the PRIME Shield warranty. This warranty is only valid to the original owner of the bow and is not transferable.

**SERVICING YOUR PRIME™ BOW:**

If you need repairs or have warranty issues with any PRIME bow, we ask you go through an authorized PRIME retail dealer. The store's service technician will be able to coordinate any replacement or warranty parts with PRIME.

**PRIME BOWS MUST BE REGISTERED BY AUTHORIZED PRIME DEALERS. REGISTRATION AND SHIELD BENEFITS LIMITED TO ORIGINAL OWNER. BOWS PURCHASED IN USED CONDITION UNDER ANY CIRCUMSTANCES ARE NOT ELIGIBLE FOR REGISTRATION.**



[WWW.G5PRIME.COM](http://WWW.G5PRIME.COM)

**PRIME**  
ARCHERY

34775 Potter St.  
Memphis, MI 48041  
Toll Free 866.456.8836  
Fax 810.392.2181

**GET LOCKED ON,  
STAY LOCKED ON!**